

# BENCH MARK

January 2020 issue . . .

- Protection Against Lightning Impacts in Aircraft: The Role of Electromagnetic Simulation
- Let's do Better Than EDA
- Validation of Electromagnetics Simulations for Vehicle-to-Everything Applications using Measured Results
- Stochastic Challenge Problems - A Summary
- Designer Oriented Software - Is it Accurate?
- How Analysis Engineers Spend their Time
- Design of 5G mm-Wave Compatible Covers for High- End Mobile Phones
- Computational Electromagnetics for Nuclear Fusion Engineering and Design
- Insight from a NAFEMS Technical Fellow

THE INTERNATIONAL MAGAZINE FOR ENGINEERING DESIGNERS & ANALYSTS FROM **NAFEMS**



The Electromagnetics Issue



# Designer Oriented Software - *Is it Accurate?*

Ian Symington, NAFEMS

**W**hen I started my first job in the CAE industry 18 years ago there were already well-established products enabling designers to leverage simulation to improve their products. Over the years the number of standalone designer oriented analysis tools has declined. Designer oriented analysis tools are now commonly included within the CAD environment and we have seen organisations successful democratise their CAE capability to design teams by providing template-based customisations/apps. This trend has changed recently and we have started hearing a lot of noise about two new designer oriented analysis tools, SimSolid from Altair and Discovery Live from ANSYS.

Before taking a dive into these products to see what they can do, it is useful to define what I mean by a “designer oriented” analysis tool.

- Firstly I’m looking for a tool that is easy to use and needs little specialist knowledge, I don’t expect the user to have to worry about selecting an appropriate element type or spend hours conducting mesh refinement studies.
- The tool needs to be “quick to run”, an analysis tool that takes hours or days to run is of no use to the designer who needs near instant answers to guide the direction of development. And by “quick to run” I’m not just talking about how well the solver performs, I’ll looking for a tool that handles the whole simulation process quickly and a big part of this is how tolerant the tool is to poor geometry.
- The tool needs to be accurate enough to correctly inform the direction that a design should take. The software doesn’t need the level of accuracy that can be achieved by a full blown general purpose analysis package but the designer, and everyone using the designer’s input, must have confidence in the tool.

## Isn't NAFEMS a Vendor Neutral Organisation?

NAFEMS most certainly is a vendor neutral organisation, but that doesn't mean that we can't take a look at software codes - it just means that we treat all vendors equally. I'm particularly interested in SimSolid and Discovery Live as they are two of the designer oriented codes that members of the community are talking to me about.

In this article I'm focussing on the accuracy of SimSolid using some simple linear benchmarks. I've had some interesting discussions with the team behind Discovery Live at ANSYS, and will hopefully be able to report on the performance of their code in a follow up article.

I would encourage any other vendor with a designer oriented code to get in touch so I can take a look. I would also encourage anyone intending on purchasing a designer oriented code to run the benchmarks for themselves. Full details of the benchmarks, including downloads of the geometry and the results, can be found in the paper "Designer Oriented Software - Evaluation" that is available for NAFEMS members to download at [nafe.ms/designer](http://nafe.ms/designer)

## Unboxing the Tools

It's worth taking a moment to consider how the vendors themselves describe their products.

*"Simsolid is a structural analysis software developed specifically for upfront assessment. It eliminates geometry simplifications and meshing, the two most time consuming and expertise extensive tasks done in traditional FEA.*

*Moreover, SimSolid can analyse complex parts and large assemblies not practical with traditional FEA and do it efficiently on a desktop class computer. Both fast and accurate, SimSolid controls solution accuracy using a unique multi-pass adaptive analysis."*

SimSolid has an impressive range of solution procedures and offers linear static, nonlinear static, modal, thermal, thermal stress and linear dynamic capabilities. After using the tool for half an hour my key takeaway is that SimSolid analyses do not involve a mesh generation phase, the geometry does not need to be defeatured, and the solve phase is quick.

Discovery Live is described as *"providing instantaneous 3D simulation, tightly coupled with direct geometry modeling, to enable interactive design exploration and rapid product innovation. It is an interactive experience in which you can manipulate geometry, material types or physics inputs, then instantaneously see changes in performance."*

It offers linear static stress analysis, modal analysis, internal fluid flow analysis, external aerodynamics and thermal analysis. The key takeaways with Discovery Live are that, like SimSolid, there is no mesh generation phase, and the tool is intended to work directly on the CAD model without defeaturing.

With both tools, in addition to not having to worry about removing small holes or the thread from the inside of a bolt hole, you also don't have to worry about midsurfacing plate structures or stringing a line between points to allow your real world component to be modelled with plate or beam elements. Both of these packages work on full 3D CAD geometry. This approach is very

attractive to the design engineer and I'm sure many of you will have seen inexperienced users drop the Tet Bomb<sup>1</sup> on a component rather than go through the tedious process of midsurfacing geometry.

Both of these packages make use of novel numerical methods. ANSYS are, understandably, keeping their method under wraps, but rumours indicate that the domain is being discretised using a voxel meshing approach. Discovery Live runs on GPU processing units, so the system you are running on will need a graphics card with at least 4GB of discrete video memory. SimSolid outline the methods behind their software in a technology white paper [3] that is available to download from the Altair resource centre, but a more accessible breakdown of both approaches is given by Tony Abbey in his excellent articles on Digitalengineering247.com [4], [5].

## The Evaluation

I've seen analysts get frustrated with designer oriented packages because they are trying to use these tools as a replacement for a full-blown general purpose analysis code. I've tried not to fall into this trap in this article and stick to simple problems that a mechanical design engineer will be familiar with.

So, what level of accuracy can you expect to get with these designer oriented codes? The tools are built to tackle complex products, but the approach taken here has been to keep the test cases simple. When a complex test case is used it often obscures the behaviour of the analysis method, so by stepping back and using simple test cases, we can truly see how accurate these methods are. Other members of our community have also been looking at the accuracy of these tools. Gregory Westwater and Dominic Lopez of Emerson Automation Solutions give us an engineer's impression of Discovery Live in their paper "Impact of Simplifications on Simulation Accuracy" [6] where they benchmark the code against real-world test cases.

## Target Solutions

The target solution used for most of the benchmarks in this study has been produced using the traditional Finite Element Analysis (FEA) approach. Confidence in the target solutions is gained using mesh convergence studies. A number of the benchmark examples reference an analytical solution - this information has been included to provide further confidence in the target solution.

## Solution Accuracy

SimSolid has a simple slider which can be used to control the accuracy of the solution. Increasing the solution accuracy comes with a penalty in solution speed. Unless otherwise stated the presented results reflect the default solution accuracy. Where a significant discrepancy was observed between the target solution and the calculated results, the analyses were rerun using the maximum accuracy setting. As this evaluation is only intended to provide an insight into the accuracy of the methods used by these tools, there is no perceived penalty with having to increase the solution accuracy in order to improve the correlation with the target solution.

SimSolid comes with a small number of additional solution controls that can improve the accuracy in certain situations e.g. when the wall thickness is thin. These additional solution controls were not employed in this evaluation.

## The Benchmarks

### Benchmark 1 – Pressure Component

The initial benchmark has been selected as it is representative of a typical problem that a designer might encounter. A long section of pressurised pipe is supported at regular intervals by trunnions. The trunnions are created from a small pipe that is shaped and then butt-welded to the pressure retaining pipeline. The trunnion does not penetrate the wall of the pressure retaining pipe. While the geometry is not particularly complex the variable radius weld connecting the trunnions to the main pipeline pose a meshing challenge. The geometry of the pipeline and trunnion support is shown in Figure 1.

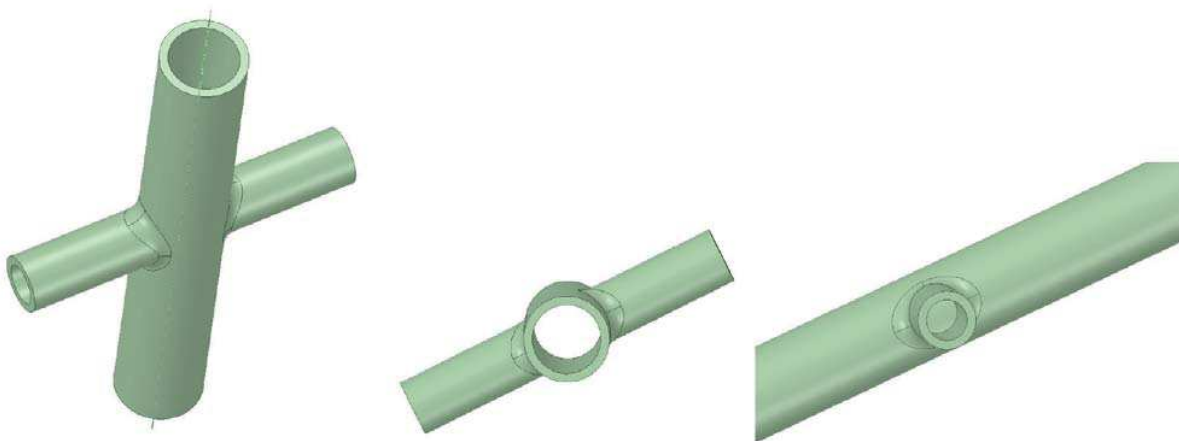

Figure 1: Geometry of the pressurised pipe with intersecting trunnion

<sup>1</sup> Tet Bomb – A meshing approach where many millions of tetrahedral elements are used to mesh structures that could have simply and efficiently been modelled if the analyst wasn't so lazy.

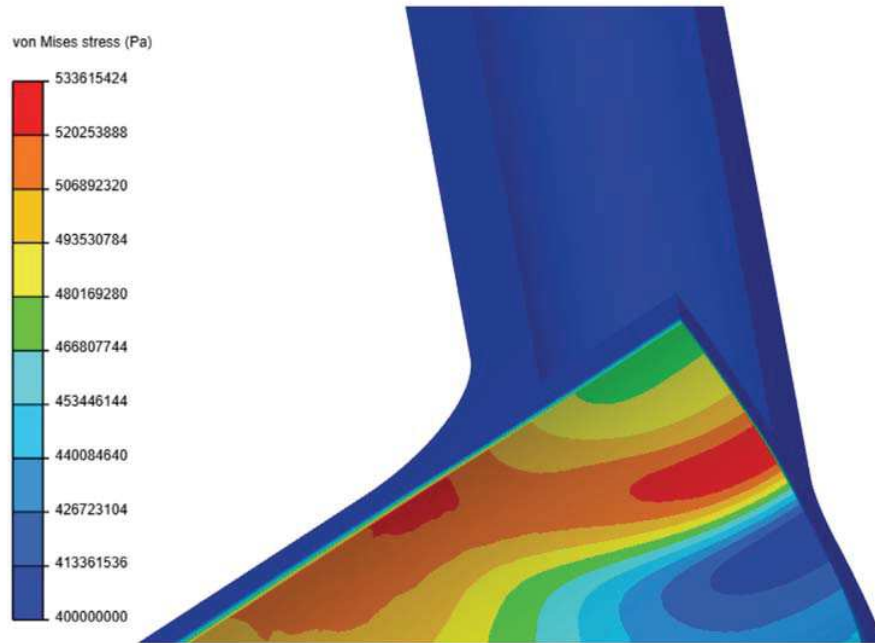

Figure 2: Contours showing Von Mises Stress in a 1/8 model of the pressured pipe and trunnion support – Contours scoped to 400-533.6MPa

The pipeline is to be analysed in order to determine if the component is appropriately designed to withstand a 100MPa pressure load. The goal of the benchmark is to predict the peak Von Mises stress in the component. The target solution is shown in Figure 2 with the target peak stress being 534MPa. The results produced by SimSolid

can be seen in Figure 3 and Table 1. The peak Von Mises stress predicted by SimSolid correlates to within 1% of the target solution. The stress contour plots produced by SimSolid reproduce the stress distribution of the target solution allowing the highly stressed areas to be identified.

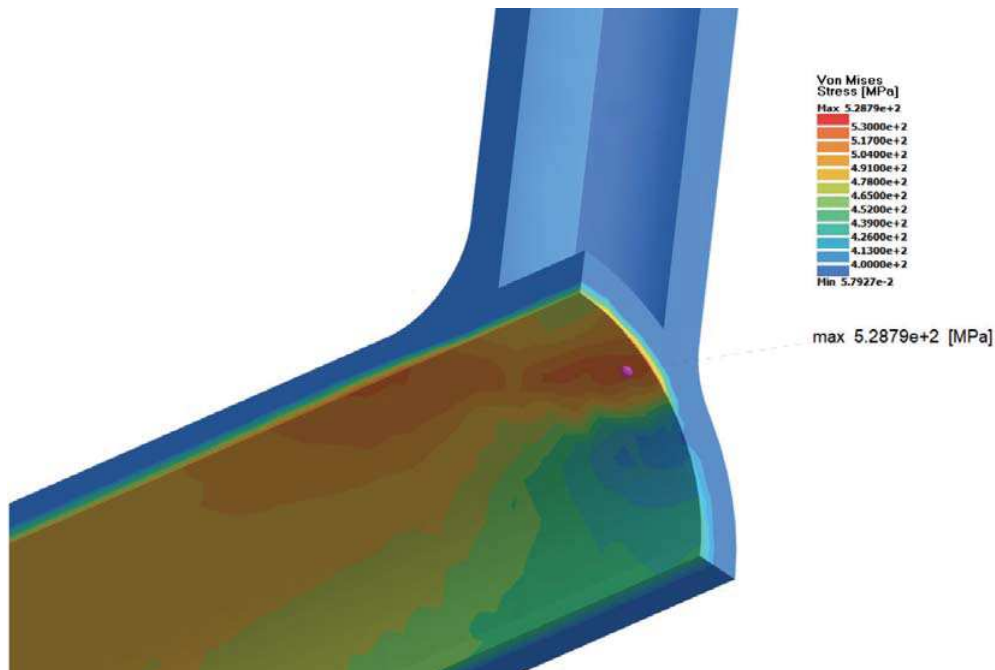

Figure 3: SimSolid - Contours showing Von Mises Stress

SimSolid		Target Solution
Max VM Stress	Deviation	530 MPa
529 MPa	<1%	

Table 1: Results from Benchmark 1 – Pressure component

### Benchmark 2 – Coil Spring

Benchmark 2 tests the ability of the package to predict the compliance of a coil spring. The coil spring is a challenging geometry to mesh using a traditional FEA approach. The challenge, target solution and results of the respondents are presented in the NAFEMS Benchmark Article "How Confident Are You?" [7]. The geometry of the coil spring can be seen in Figure 4.

The target solution is described in [7] and was produced using the p-element FE formulation. The target spring rate is 20.8N/mm.

The spring rate is calculated in SimSolid by interrogating the reaction force required to displace the spring by 1mm and is reported in Table 2. In can be seen that SimSolid is able to reproduce the target solution with a high degree of accuracy.

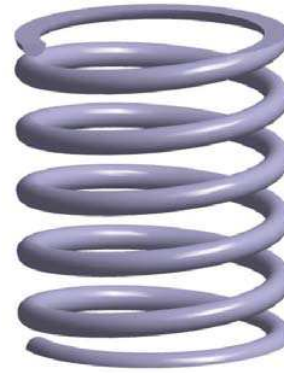

Figure 4: Geometry of the coil spring used in Benchmark 7

SimSolid		Target Solution (N/mm)
Spring Rate (N/mm)	Deviation	
20.76	<1%	20.80

Table 2: Coil spring compliance results

### Benchmark 3 –Thin Skew Plate in Bending

The third benchmark tackles a thin skewed plate. The skewed plate geometry is designed to introduce complexities in the discretisation process and may introduce distorted elements in an automatic meshing process. The thin skewed plate is simply supported and loaded with a uniform pressure. This benchmark is taken from the NAFEMS Linear Static Benchmarks Volume 1 [8], test number IC 13. The geometry of the skewed plate is shown in Figure 5.

An analytical solution is provided in [8] and this indicates that the maximum principal stress in the centre of the plate's lower surface should be 0.802 MPa. The target solution of 8.2MPa was produced using a general purpose FEA package using a shell element approach (Figure 6).

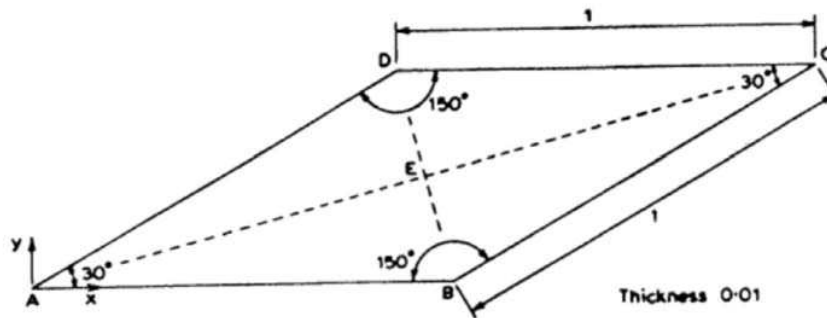

Figure 5: The geometry of the skewed plate

Maximum Principal Stress  
 Type: Maximum Principal Stress (Unaveraged)  
 Unit: Pa  
 Time: 1  
 29/10/2019 11:17

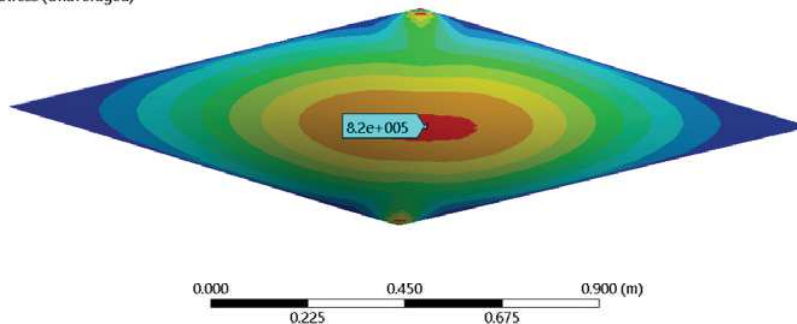
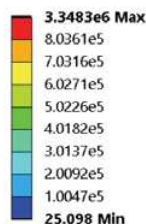

Figure 6: Traditional FEA approach - Maximum principal stress on plate lower surface



The maximum principal stress results produced by SimSolid can be seen in Figure 7 and Table 3. Both the traditional FEA approach and designer oriented software package predict high stresses at corners B and D. These stresses are not considered in this benchmark and attention is focussed on the stress in the centre of the plate's lower surface. The "Pick Info" tool in SimSolid is used to probe the model in the vicinity of the centre of the plate to obtain the stress result. This tool reports the stress and the coordinates of the point that has been picked so there is a high degree of confidence that the results at plate centre have been queried. SimSolid predicts the target solution with a high degree of accuracy.

Result	SimSolid		Target Solution
	Result	Deviation	Result
Maximum principal stress (MPa)	0.82	<1%	0.82

Table 3: Result summary – Skew plate

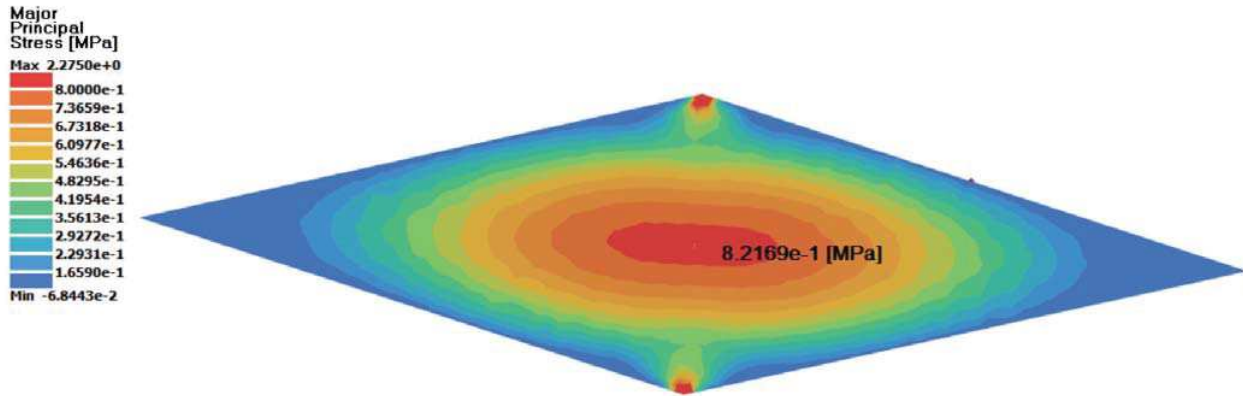

Figure 7: SimSolid - Maximum principal stress on plate lower surface – Benchmark 4

**Benchmark 4 – Stress Concentration Plate with Hole**

This benchmark tests the ability of the code to capture a stress concentration in a plate containing a small hole. The benchmark has been designed so that the extent of the plate is large in comparison to the size of hole so as to pose a challenge when sizing the mesh in the vicinity of the stress concentration. The geometry used by benchmark 4 is shown in Figure 8.

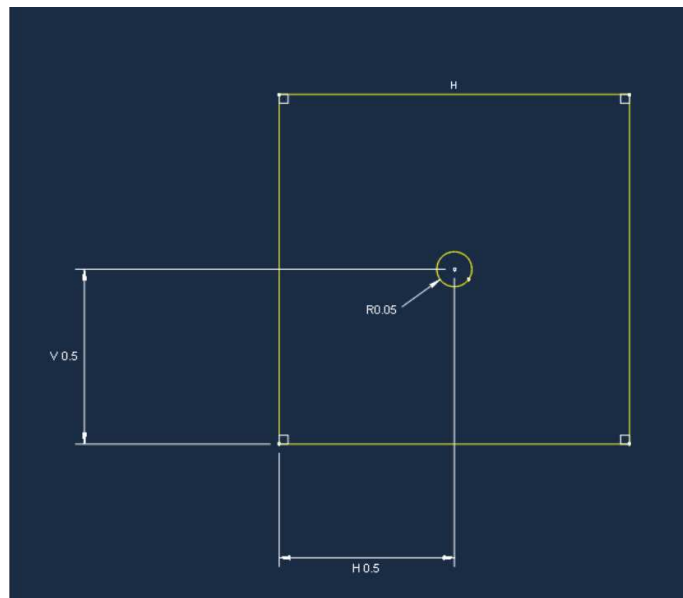

Figure 8: Geometry of the plate with hole benchmark

While many analytical solutions are available for this problem, e.g. Roark or Peterson, they do not capture the through thickness variation in principal stress at the plate hole and so a traditional FEA model was again used to obtain the target solution. The target principal stress solutions can be seen in Figure 9, with the SimSolid results available in Figure 10 and summarised in Table 4.

SimSolid correctly identifies the locations of the maximum and minimum principal stresses. Under the default level of solution accuracy, the peak stress results deviate from the target solution by up to 11.3%, and so the analysis was rerun using the highest level of solution accuracy, reducing this deviation to within 4.2% of the target solution.<sup>2</sup>

Solution Accuracy	Result Quantity	SimSolid		Target Solution (MPa)
		Result (MPa)	Deviation	
Default	Maximum principal stress	347.7	10.7%	314
Maximum	Maximum principal stress	325.7	3.7%	
Default	Minimum principal stress	-136.1	11.3%	-114
Maximum	Minimum principal stress	-117.9	4.2%	

Table 4: Results of Benchmark 4 – Plate with Hole

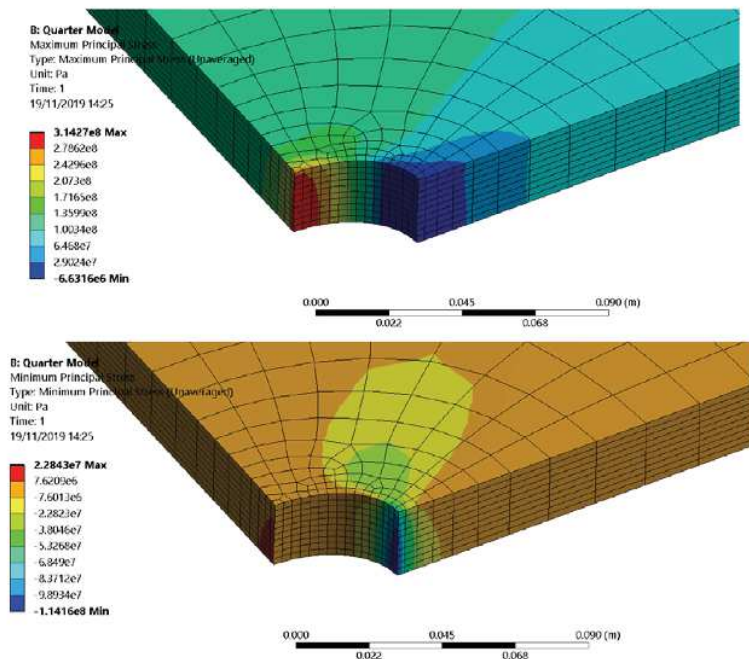

Figure 9: Principal stress target solutions – Maximum (top) – Minimum (bottom)

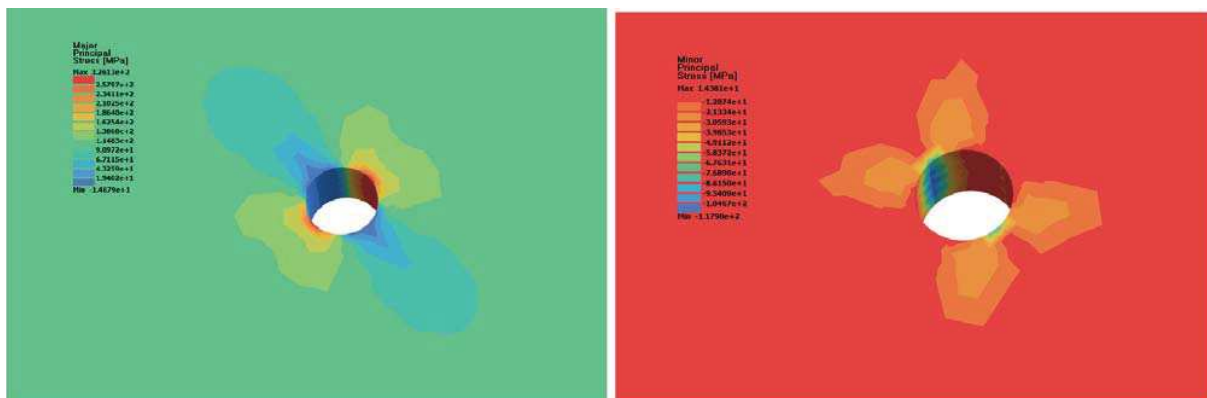

Figure 10: SimSolid maximum principal stress (left) and minimum principal stress (right) – Benchmark 5 – Plate with hole – Maximum accuracy setting

<sup>2</sup> Altair have pointed out that a more accurate solution can be obtained with SimSolid if a 1/8th section of the geometry and appropriate symmetry boundary conditions are utilised. As these tools are intended to work on the as built CAD model the full geometry is used in this benchmark..



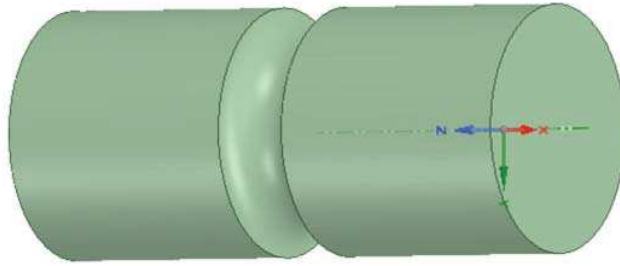

Figure 11: The geometry of the shaft with U-shaped notch benchmark

**Benchmark 5 –Stress Concentration Shaft Notch**

Benchmark 5 is again intended to test if the software package can appropriately capture a stress concentration. This benchmark uses a circular shaft loaded in uniaxial tension with a U-shaped notch running around the entire circumference of the shaft at midspan (Figure 11).

The target solution was produced using an axisymmetric FEA model and the peak principal stress in the vicinity of the notch is the value that is used when assessing the “designer oriented” code results.

The peak principal stresses predicted by SimSolid can be seen in Table 5 and Figure 13. As the SimSolid results under the default solution accuracy deviated from the target solution, the analysis was rerun using the maximum accuracy setting. When the SimSolid accuracy maximum setting is used there is a very good correlation between the predicted results and the target solution (within 2%).

Solution Accuracy	SimSolid	Target Solution	
	Max Principal Stress (MPa)	Deviation	Max Principal Stress (MPa)
Default	42.1	12.7%	48.2
Maximum	47.6	1.2%	

Table 5: Results of Benchmark 5 – Benchmark 5

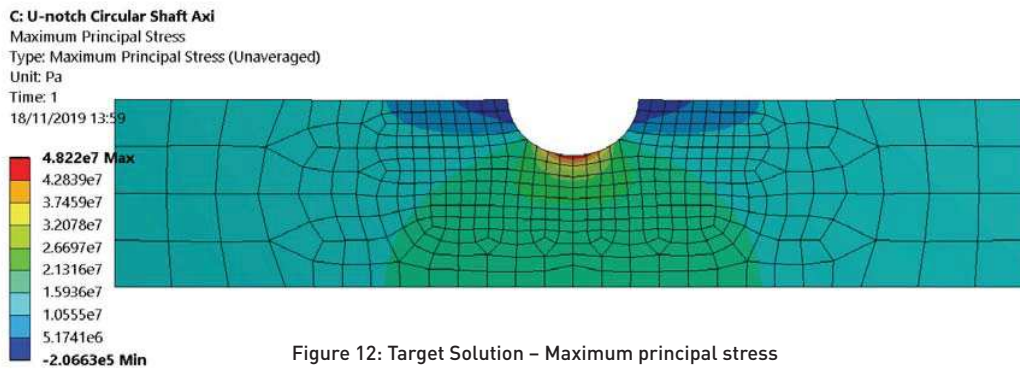

Figure 12: Target Solution – Maximum principal stress

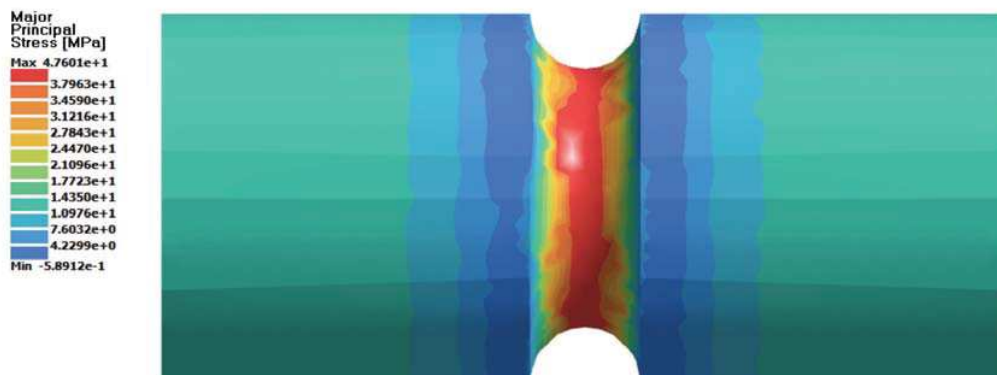

Figure 13: Maximum principal stress - SimSolid – Maximum accuracy – Benchmark 5

### Benchmark 6 – Natural Frequency Thin Cantilevered Plate

This benchmark explores the ability of the software package to accurately predict the first five modes of vibration of thin square plate constrained to act as a cantilever. The plate measures 10 x 10 x 0.05m. An analytical reference solution to this problem is provided in the NAFEMS Publication "Selected Benchmarks of Natural Frequency Analysis" [9]. The target solution is obtained using a traditional FEA approach whereby the geometry was midsurfaced and meshed with first order shell elements.

The natural frequency predicted by SimSolid associated with the first five modes of vibration can be seen in Table 6. Both the mode shapes and the predicted natural frequencies are an excellent match to the target solution.

Result	SimSolid		Target Solution (Hz)
	Result (Hz)	Deviation	
Mode 1	0.42	0.7%	0.42
Mode 2	1.02	-0.2%	1.02
Mode 3	2.56	0.8%	2.58
Mode 4	3.27	0.6%	3.29
Mode 5	3.72	0.8%	3.75

Table 6: Results of Benchmark 7 – Modal – Thin cantilever plate

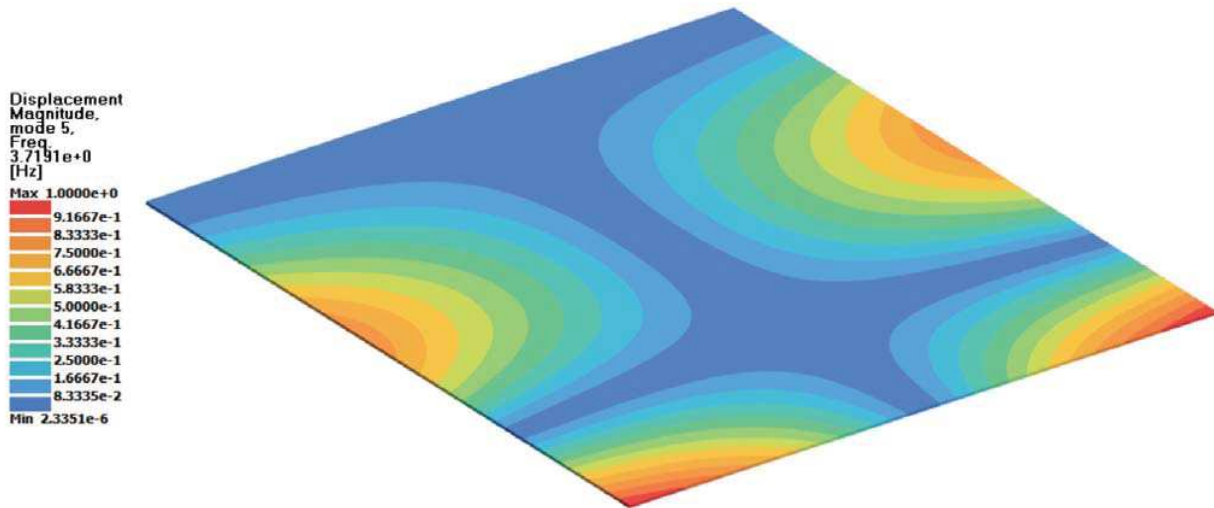

Figure 14: SimSolid - Displaced mode shape – Mode 5 – 3.72Hz – Benchmark 7

**Benchmark 7 – Cantilever Under End Load**

On first inspection, the simple cantilever beam bending problem described in this benchmark appears trivial. The reason for including a pure bending problem in this study is because it can often highlight deficiencies in both element formulation and the refinement of the automatically generated mesh. The cantilever in question has a square cross-section and is loaded with a distributed force acting on the end face. The target solution can be obtained from an engineering handbook or using general purpose FEA code. Both the peak deflection and bending stress are defined as the targets of this benchmark.

The target displacement and stress results produced by SimSolid are shown in Table 7, Figure 15 and Figure 16. SimSolid is able to accurately represent the stiffness of the beam under bending, and has an excellent correlation with the target stress result.

Result	SimSolid		Target Solution Traditional FEA	
	Result	Deviation	Result	Deviation
Displacement	0.0247m	<1%	0.0247m	<1%
Sxx	221.7MPa	<1%	221.8MPa	<1%

Table 7: Results of Benchmark 7 – Cantilever Beam.



Figure 15: SimSolid – Direction stress acting in a direction parallel to the length of the beam



Figure 16: SimSolid – Deformation in the direction of the applied load



### Benchmark 8 – Cantilever Under End Load – Stress Concentration

The geometry used in Benchmark 7 was extended and built into a larger structure with the intention of exploring the stress concentration at the point of connection. A 5mm fillet radius is used to smooth the transition between cantilever and supporting structure. Due to the small size of the fillet radius in regard to the height and length of the component's major dimensions, accurately capturing the stress concentration is not a trivial task.

The geometry of the modified cantilever can be seen below in Figure 17. The target solution for benchmark 8 is produced using a traditional FEA package. Confidence that an appropriate mesh density had been selected was achieved via a mesh refinement study.

The goal of this benchmark is to predict the peak Von Mises stress in the vicinity of the small fillet. The target solution and the results of the SimSolid analysis can be seen in Table 8 and Figure 18 and Figure 19.

SimSolid was able to replicate the approximate stress distribution predicted by the traditional FEA approach however the peak Von Mises stress reported varies significantly with the accuracy setting. Under the maximum solution accuracy setting SimSolid was within 3% of the target solution.

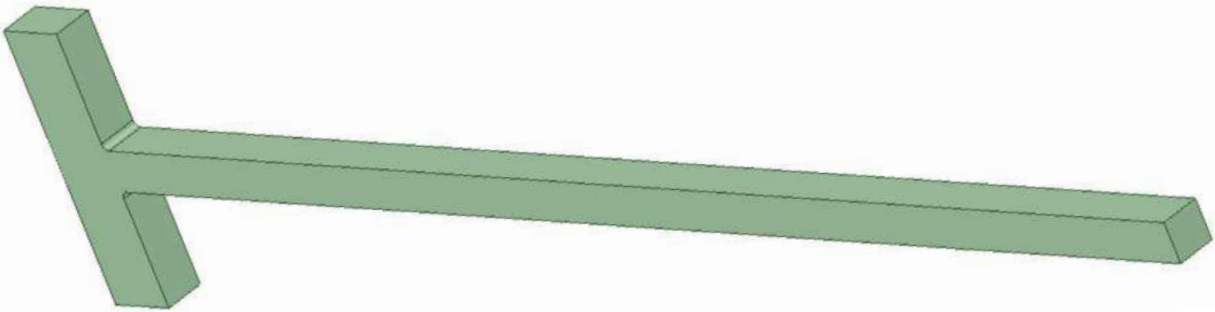

Figure 17: Geometry of the modified cantilever used for Benchmark 8

Solution Accuracy	SimSolid		Traditional FEA
	VM Stress (MPa)	Deviation	Result (MPa)
Default	252.0	29.3%	356.5
Maximum	366.5	2.8%	

Table 8: Benchmark 8 – Maximum Von Mises Stress

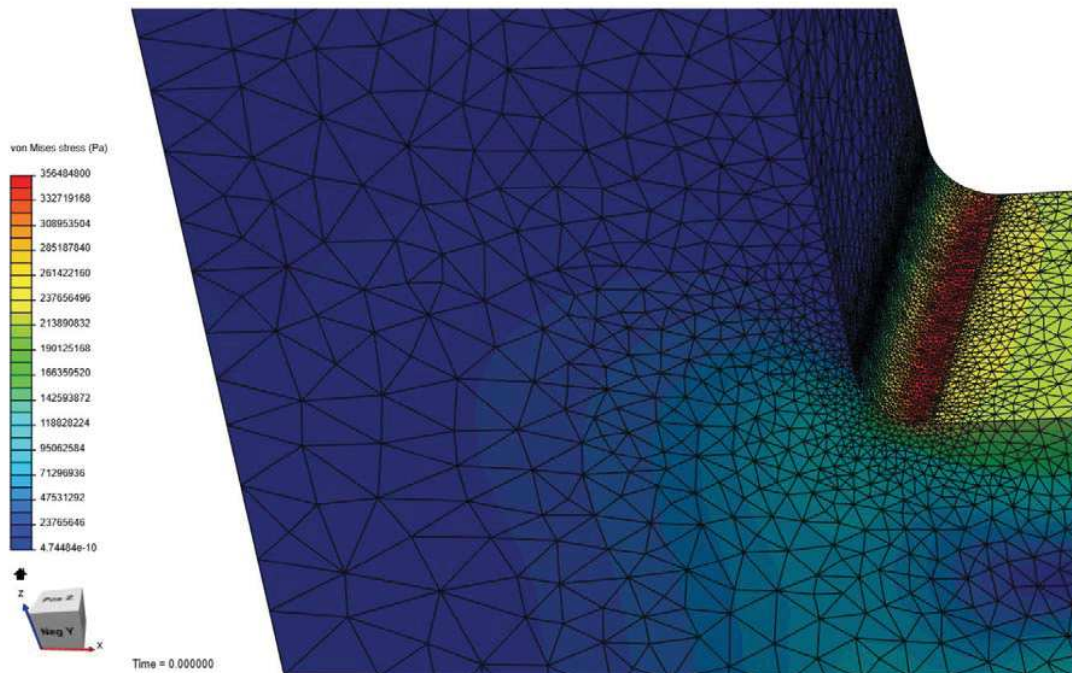

Figure 18: Traditional FEA approach - VM Stress and mesh from the 3rd iteration of the mesh refinement study

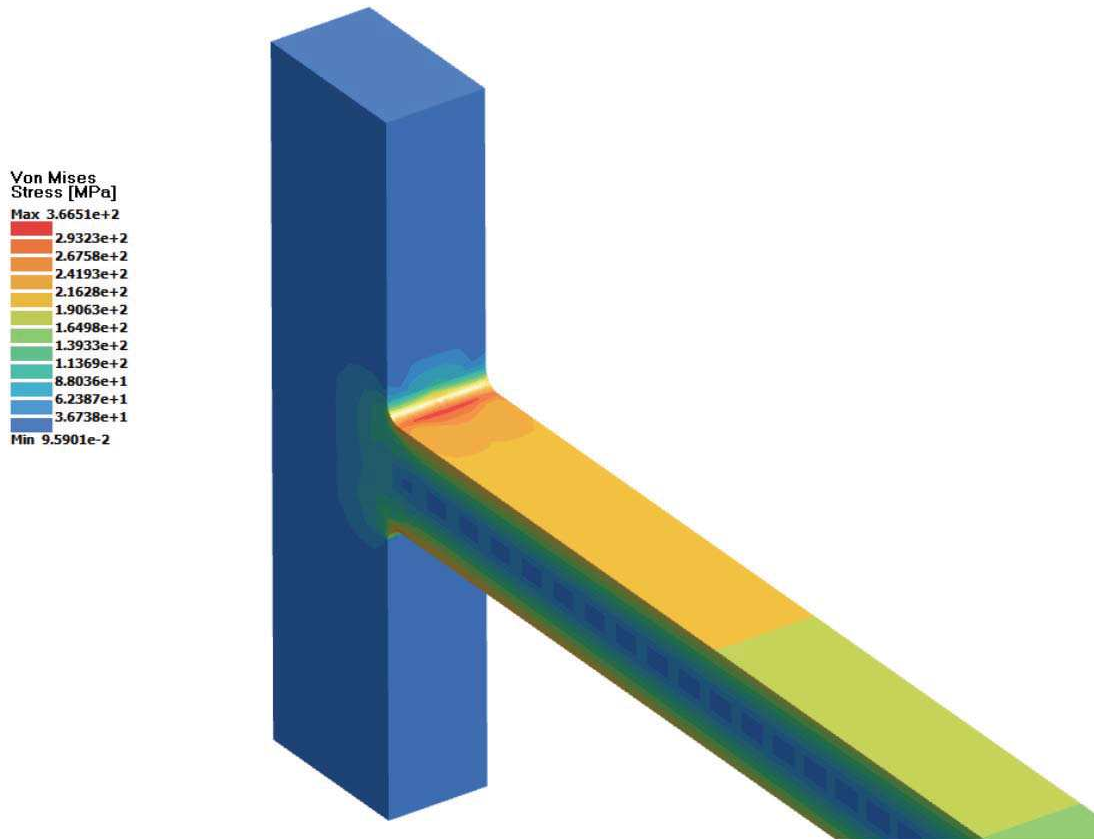

Figure 19: SimSolid – Von Mises Stress

## Summary

A summary of the results from the eight benchmarks can be found in Table 9. For the benchmarks considered in this study the maximum discrepancy between the target and SimSolid solution is 4.2%. While the benchmarks are intentionally simple, the correlation is surprisingly good considering that the time-consuming process of meshing has been removed. The software is easy to use and all of the benchmarks took a matter of minutes to set up and analyse.

The sort of testing that has been performed here should just be one small part of the software evaluation process. I've only considered a limited number of problems, and the tests were deliberately simple in nature. I would encourage readers to evaluate the software using their own representative benchmarks.

These tests have shown that, for the selected problems, it is possible to obtain accurate results without user involvement in the discretisation (meshing) process. The limitations of the "designer oriented" software become

apparent when trying to generate confidence in the predicted results. The software does not make error estimation measures available to the user, and the option of iterating by increasing the mesh density is not available.

The user must treat the software as a black box and trust the results. This should not necessarily be seen as a black mark: the tool is marketed as being "designer oriented" and if confidence is needed in predicted results then the analysis should be run in a full-blown general-purpose FEA package.

NAFEMS members interested in further details of the benchmarks are available in the "Designer Oriented Software– Evaluation" report, available at [nafe.ms/designer](http://nafe.ms/designer). I encourage vendors of other designer oriented codes to get in touch so that your code can be included in this evaluation. If you are actively looking at these types of code, then please try the tool out on the benchmarks described in this article and get in touch at [benchmark@nafems.org](mailto:benchmark@nafems.org) to tell us how you get on.

Benchmark	Description	Quantity	Target Solution	SimSolid	
				Results	Discrepancy
1	Pressure component	Von Mises stress	534MPa	532MPa	<1%
2	Coil spring	Spring rate	20.8N/mm	20.76N/mm	<1%
3	Skew plate	Maximum principal stress	0.82MPa	0.82MPa	<1%
4	Plate with hole	Maximum principal stress	314MPa	325.7MPa	3.7%
		Minimum principal stress	-114MPa	-117.9MPa	4.2%
5	U-shaped notch	Maximum principal stress	48.2MPa	47.6MPa	1.2%
6	Cantilevered plate	Mode 1	0.42Hz	0.42Hz	<1%
		Mode 2	1.02Hz	1.02Hz	<1%
		Mode 3	2.58Hz	2.56Hz	<1%
		Mode 4	3.29Hz	3.27Hz	<1%
		Mode 5	3.75Hz	3.72Hz	<1%
7	Cantilever under pure bending	Sxx	221MPa	221.7MPa	<1%
		Uz	0.0247m	0.0247m	<1%
8	Cantilever realistic support	S <sub>VM</sub>	356.5MPa	366.5MPa	2.8%

Table 9: A summary of results for all benchmarks

## References

- [1] "Altair SimSolid™ Structural Analysis for Rapid Design Iterations," Altair Engineering, Inc, 2019. [Online]. Available: <https://www.altair.com/simsolid/>. [Accessed 11 December 2019].
- [2] "Discovery Live Real-time Engineering Simulation for Rapid Product Exploration," ANSYS, [Online]. Available: <https://www.ansys.com/products/3d-design/ansys-discovery-live>. [Accessed 21 November 2019].
- [3] Altair, "Altair Simsolid Technology Overview".
- [4] T. Abbey, "Altair SIMSOLID Walkthrough," Digital Engineering, 1 June 2019. [Online]. Available: <https://www.digitalengineering247.com/article/altair-simsolid-walkthrough/simulate>. [Accessed 21 November 2019].
- [5] T. Abbey, "Meshless FEA Opportunities," Digital Engineering, 1 January 2019. [Online]. Available: <https://www.digitalengineering247.com/article/meshless-fea-opportunities>. [Accessed 21 November 2019].
- [6] G. D. Westwater and D. L. Lopez, "Impact of Simplifications on Simulation Accuracy," *NAFEMS World Congress Proceedings*, 2019.
- [7] B. Szabó, "How Confident Are You?," 01 July 2019. [Online]. Available: [https://www.nafems.org/publications/resource\\_center/bm\\_jul\\_19\\_4/](https://www.nafems.org/publications/resource_center/bm_jul_19_4/). [Accessed 12 September 2019].
- [8] D. Hitchings, A. Kamoulakos and G. Davies, *Linear Static Benchmarks Volume 1*, NAFEMS, 1987.
- [9] F. Abbasian, D. Dawswell and N. Knowles, *Selected Benchmarks For Natural Frequency Analysis*, NAFEMS, 1987.
- [10] W. C. Young and R. G. Budynas, *Roark's Formulas for Stress and Strain*, Seventh Edition ed., McGraw- Hill, 2002.
- [11] "Finite Element Analysis, Perform FEA simulations in your browser," SIMSCALE, [Online]. Available: <https://www.simscale.com/product/fea/>. [Accessed 20 November 2019].
- [12] "Mechanical Enterprise," ANSYS, [Online]. Available: <https://www.ansys.com/products/structures/ansys-mechanical-enterprise>. [Accessed 20 November 2019].
- [13] "CATIA V5-6R2016 DRIVES HIGHER DESIGN EXCELLENCE," Dassault Systèmes, 21 November 2019. [Online]. Available: <https://www.3ds.com/products-services/catia/products/v5/portfolio/domain/Analysis/>.
- [14] Altair, "Altair Acquires SIMSOLID," Altair, 17 October 2018. [Online]. Available: <https://www.altair.com/news/11555/>. [Accessed 21 November 2019].
- [15] "Discovery Live Real-time Engineering Simulation for Rapid Product Exploration," ANSYS, Inc, 2019. [Online]. Available: <https://www.ansys.com/products/3d-design/ansys-discovery-live>. [Accessed 11 December 2019].

Ian Symington is currently Technical Officer at NAFEMS. A chartered mechanical engineer with a Masters Degree in Engineering, he has over 18 years of experience working in the simulation industry for software vendors, industrial OEMs and consultancies. In his current role Ian is responsible for coordinating the 15 technical working groups operated by NAFEMS. He can be contacted at [technical@nafems.org](mailto:technical@nafems.org).

The work presented in this article is the opinion of the author and no compensation or endorsement was received. Ian would like to thank Baljesh Mehmi, Stephen White and Ken Welch at Altair for their help and patience in responding to the many questions and queries that spring to the mind of an engineer with a new toy.